



Cavity Beam Position Monitor Development at CTF3

S. T. Boogert, **F. Cullinan**, A. Lyapin, **J. Towler**

JAI at Royal Holloway, University of London

W. Farabolini, T. Lefevre, L. Soby, M. Wendt

CERN

CLIC Experimental Verification Meeting 2013

CERN

Cavity BPM Principle

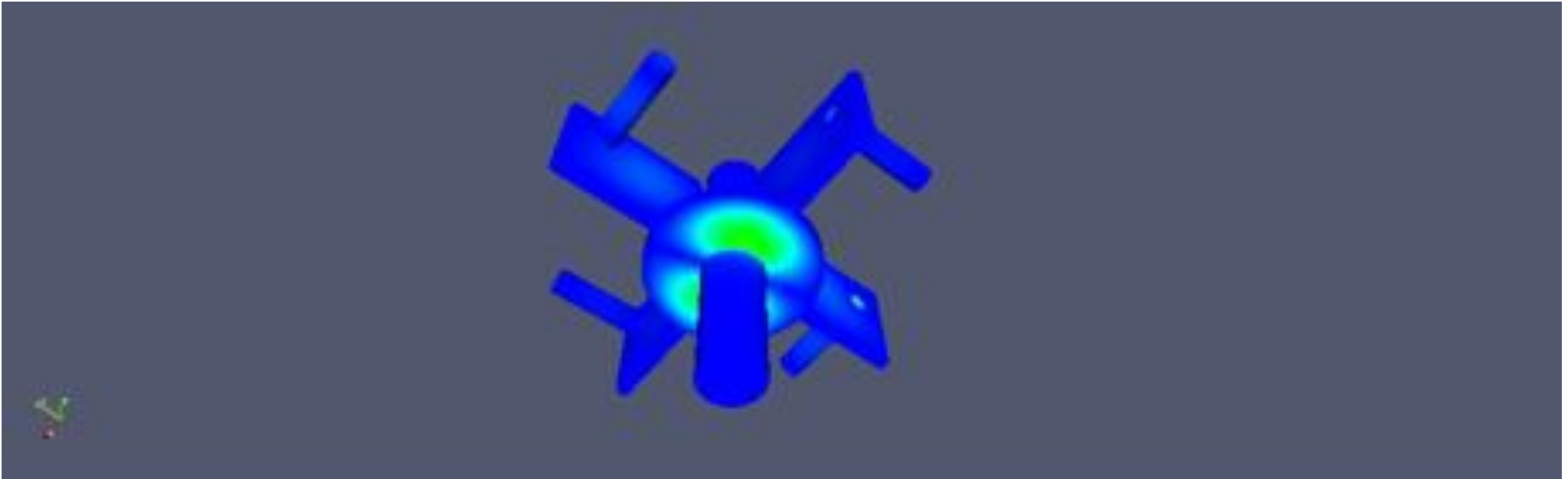

+ Reference cavity
Charge normalisation and beam arrival phase

+ Receiver electronics
Gain, down-mixing and filtering

+ Digital signal processing

Application to CLIC



- For 3 TeV centre of mass energy, ≈ 5000 BPMs in total for the main linac and beam delivery system
- 50 nm resolution required as well as multiple position measurements within a single bunch train

Stainless steel for low quality factor and small time resolution

Position cavity with waveguides

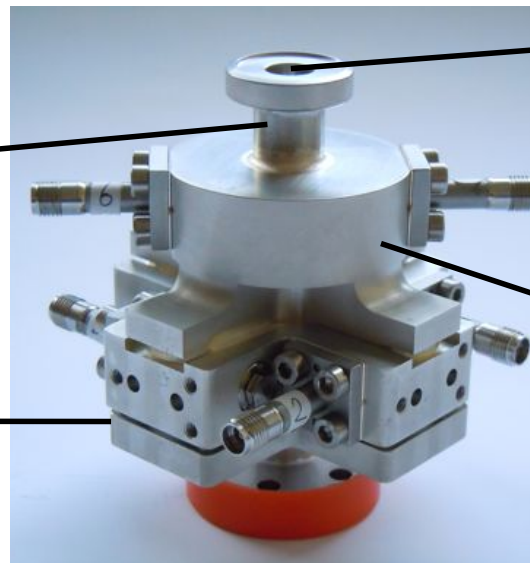

8 mm aperture

Reentrant reference cavity

N. Chritin et al., *A High Resolution Cavity BPM for the CLIC Test Facility*, BIW10, Santa Fe, New Mexico

Down Converter

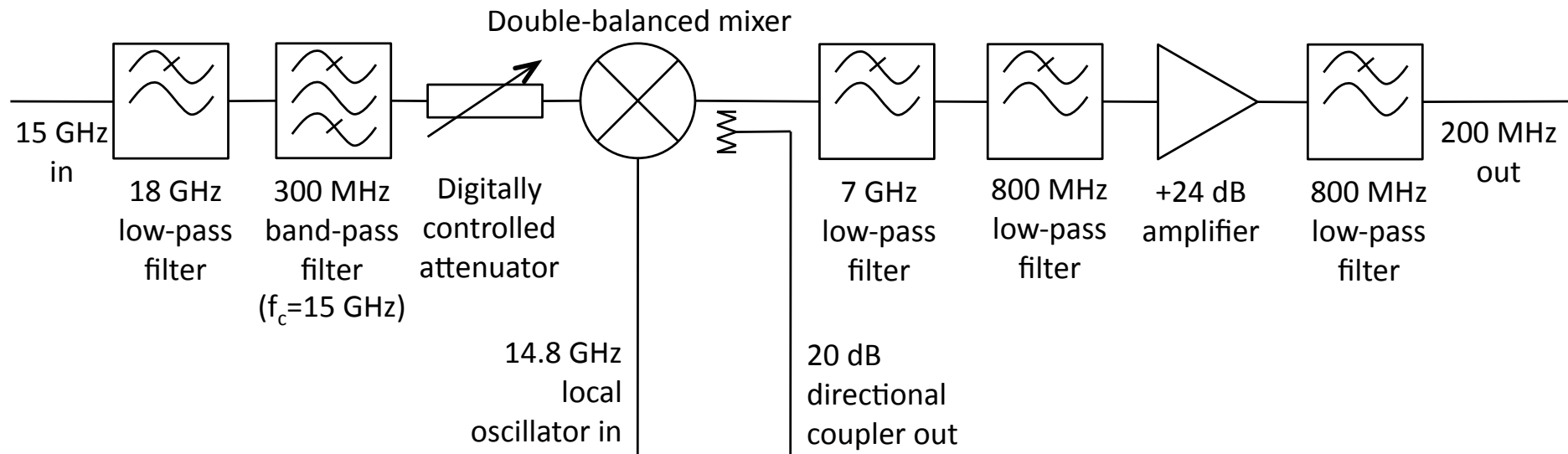
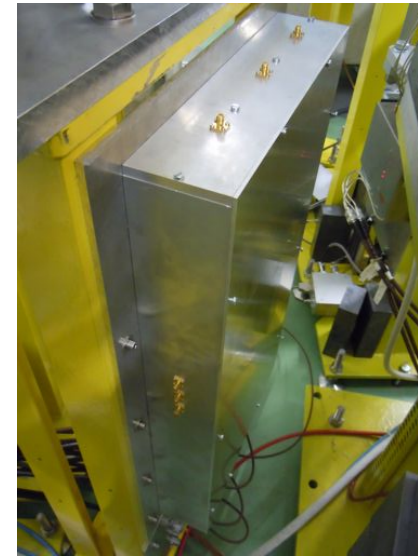

CTF3 Installation

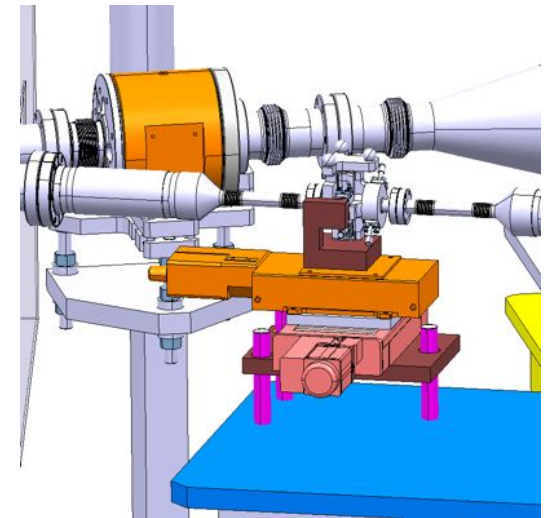

D. Bastard, CERN

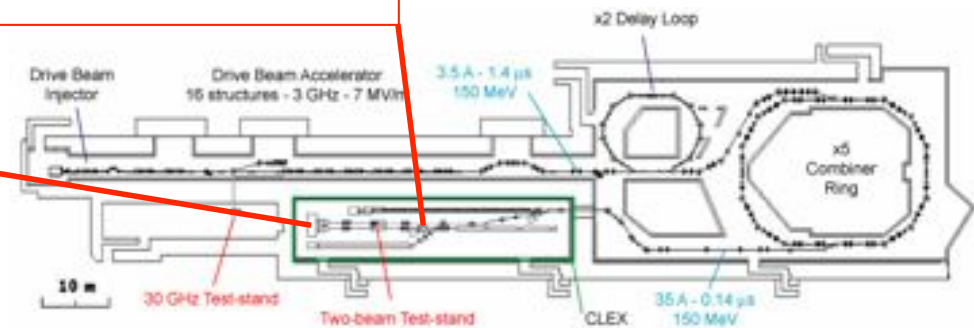
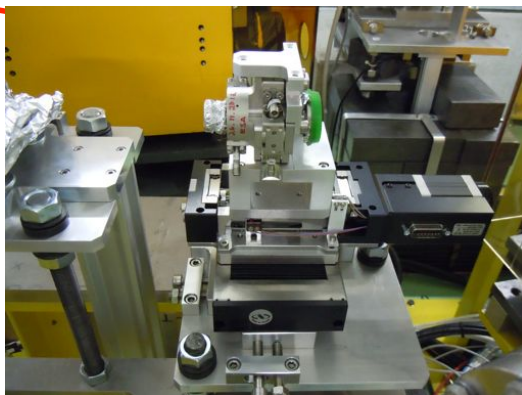
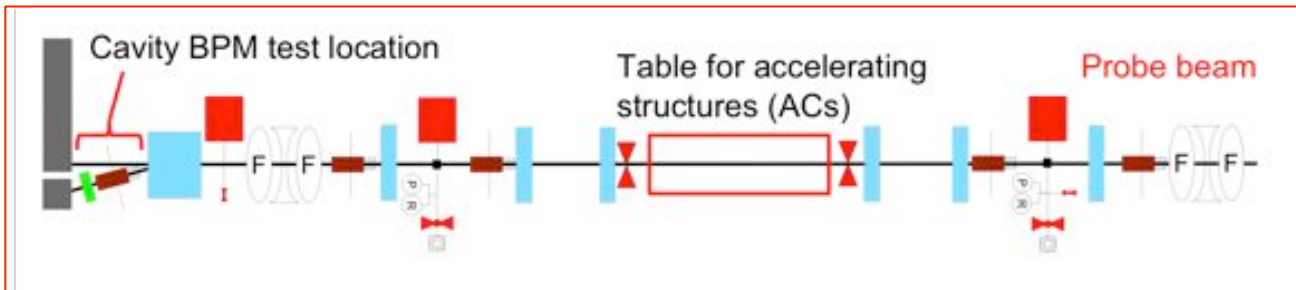

Other Installations

- Rectifying diodes for preliminary sensitivity measurements (J. Towler, M. Wendt, CERN)
- Local oscillator box (A. Lyapin, RHUL)



- Attenuator control board (G. Boorman, O. Popoolah, RHUL)



- OTR system (T. Lefevre, CERN)



Signals

- 2.1 ns pulse length

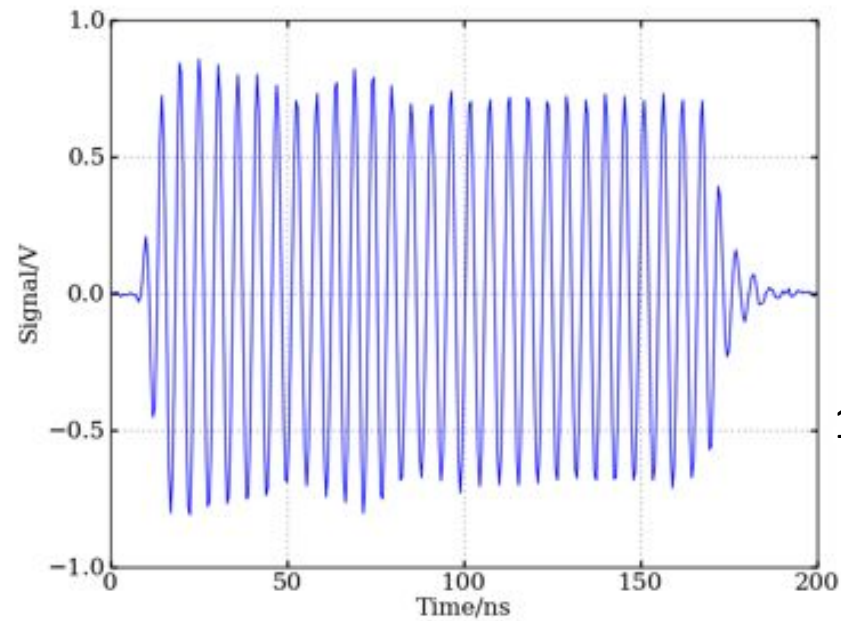

160 ns pulse scan

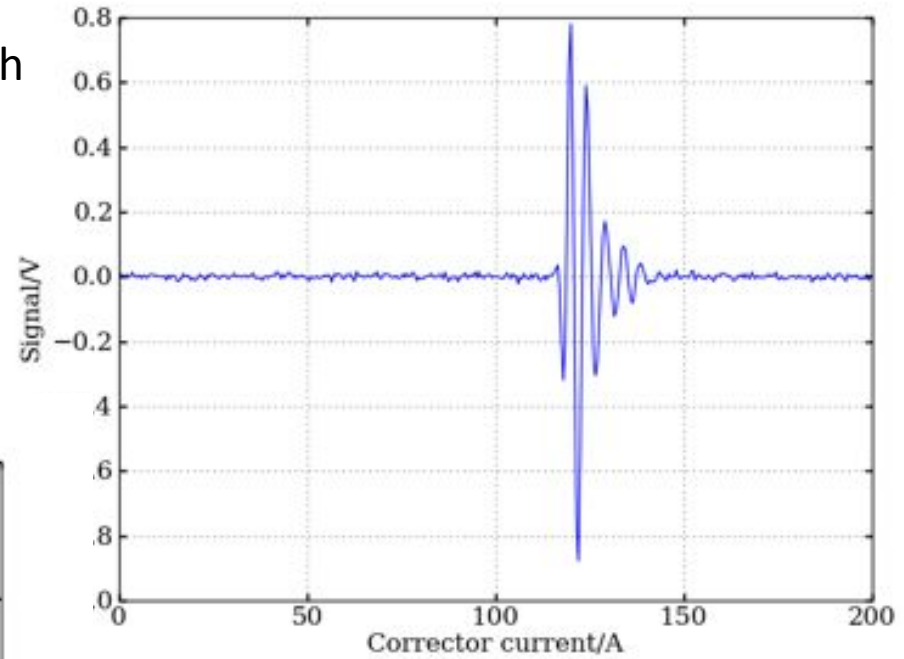

Digital Signal Processing

- Down convert to 200 MHz in tunnel
- Digitally demodulate and sample amplitude and phase just after the peak
- Normalise the amplitude to remove charge dependence and reference the phase for beam angle dependence
- In-phase (I) and quadrature-phase (Q) components

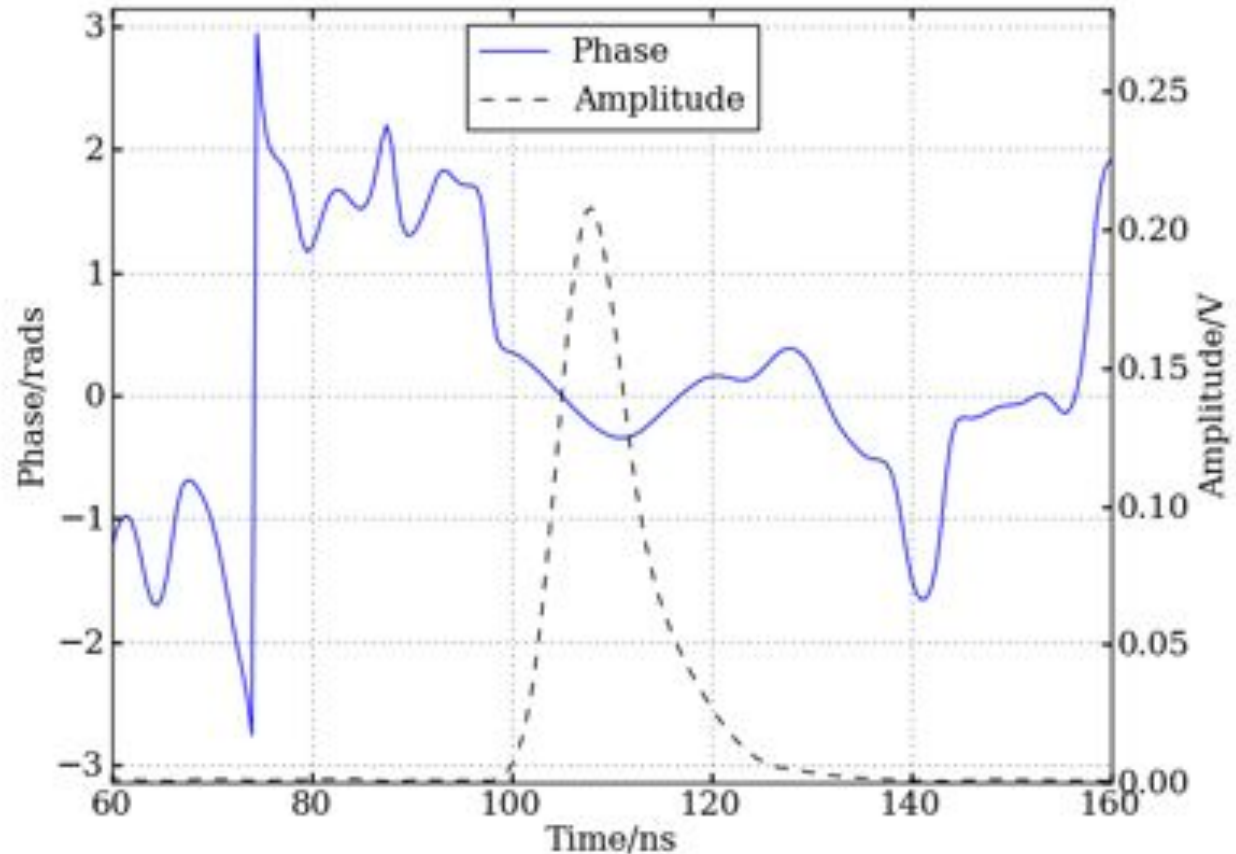

$$I = \frac{A_p}{A_r} \cos(\phi_p - \phi_r)$$

$$Q = \frac{A_p}{A_r} \sin(\phi_p - \phi_r)$$

Corrector Scan

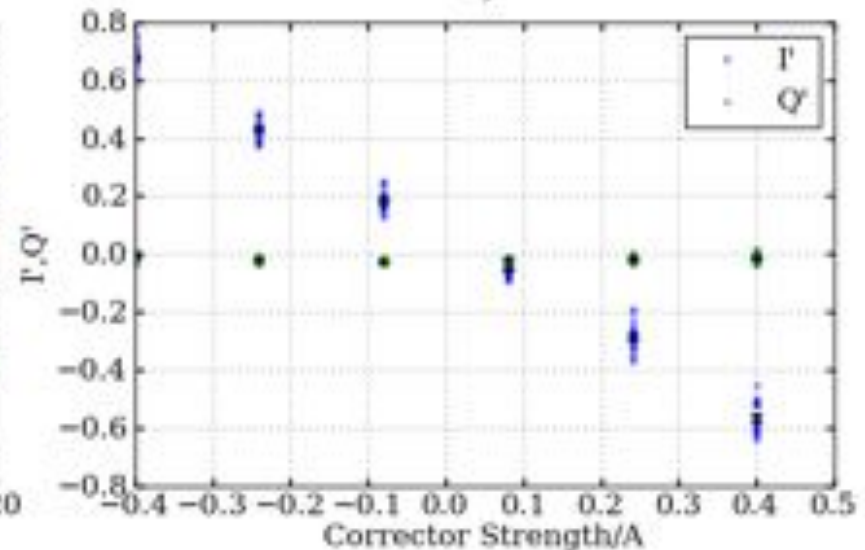
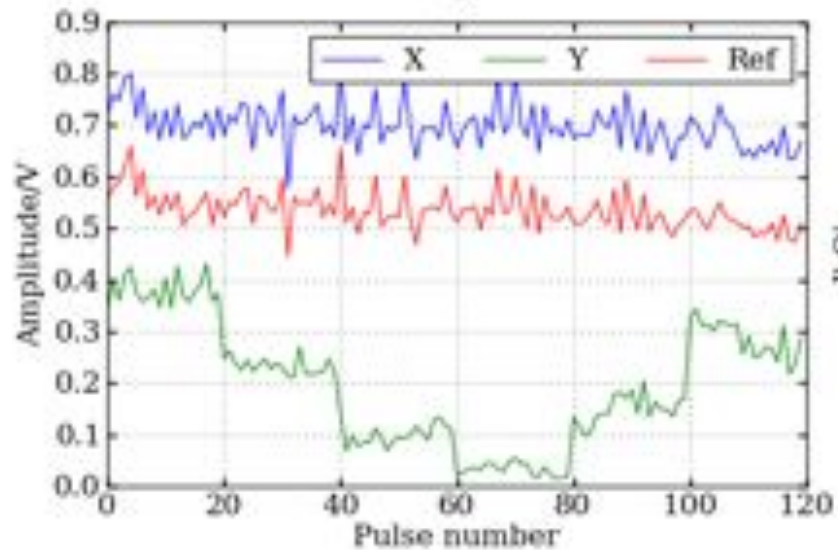
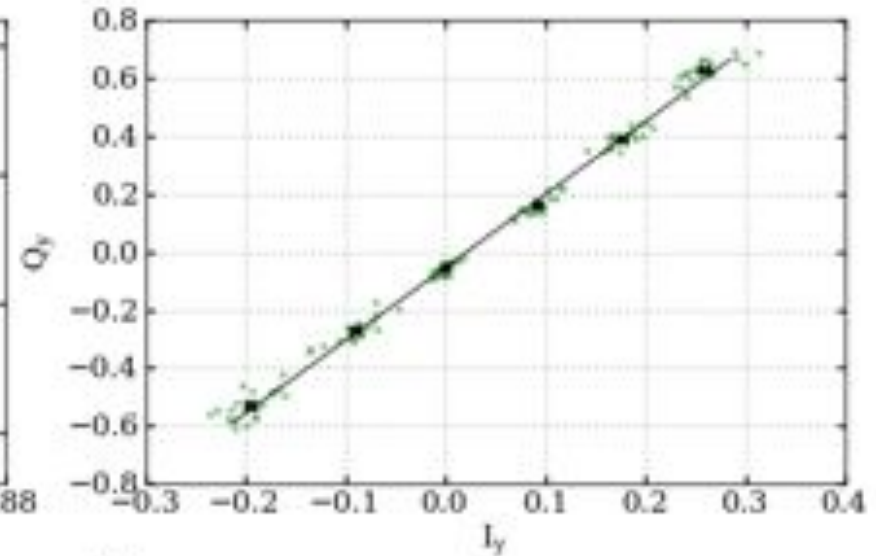
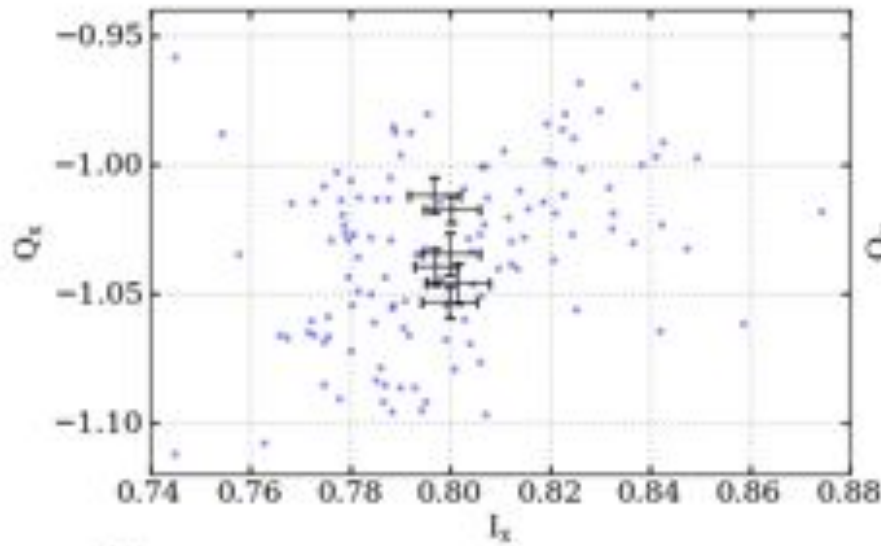

Vertical Calibration

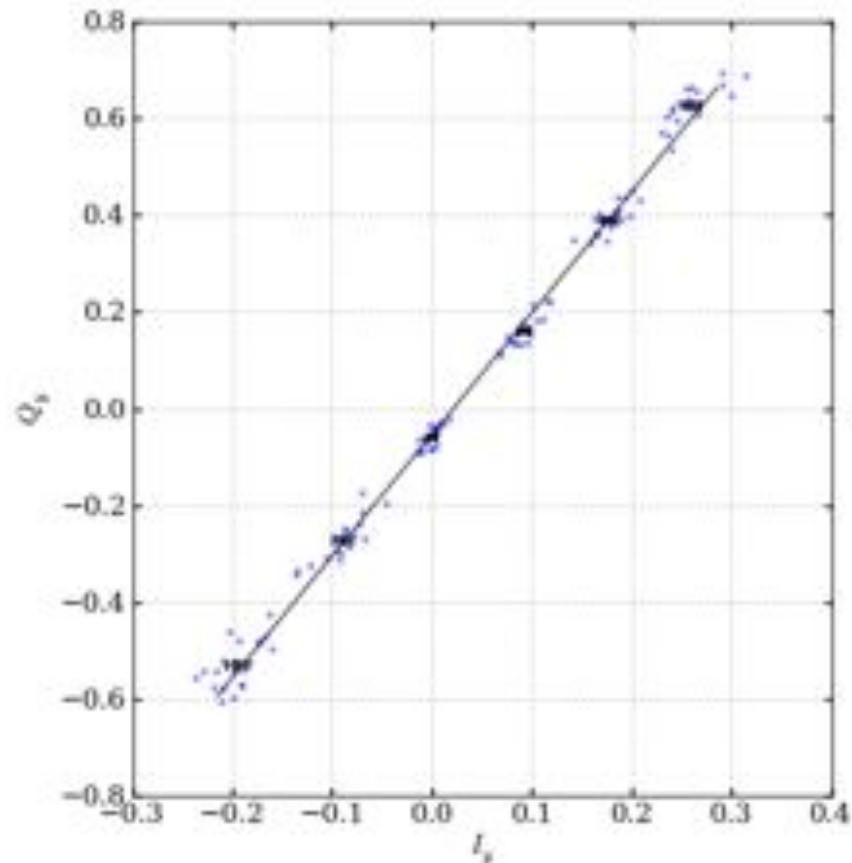

IQ rotation angle : 68.3 ± 0.8 degrees
 $\chi^2 / \text{d.o.f.} : 1.74$

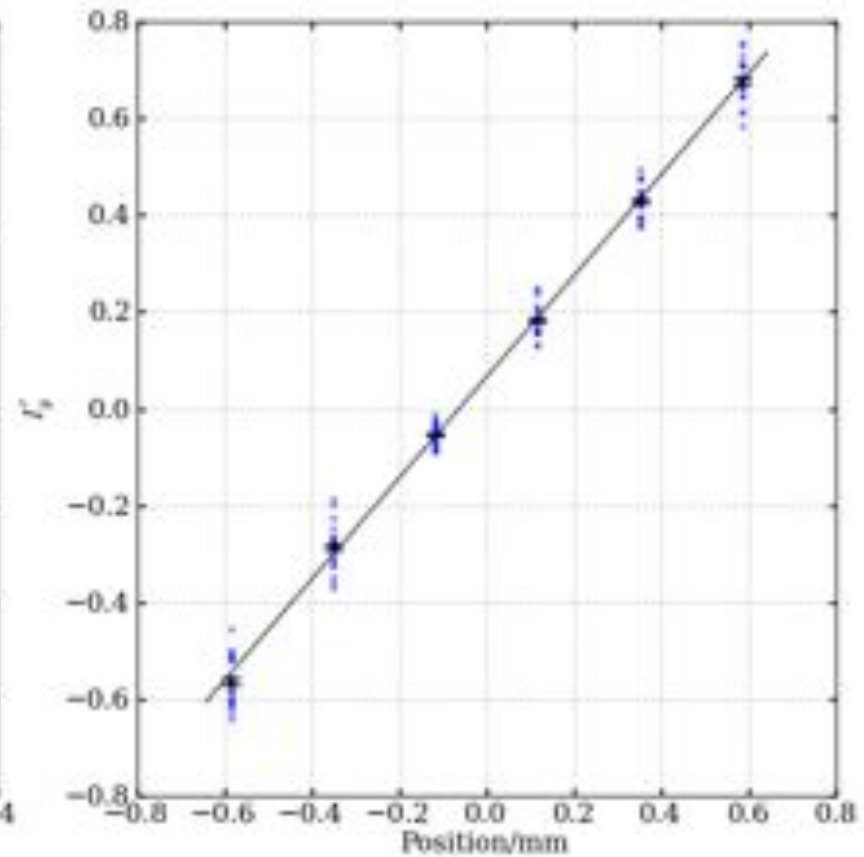

Position scale factor : 0.957 ± 0.008 mm
 $\chi^2 / \text{d.o.f.} : 1.69$

Corrector Response

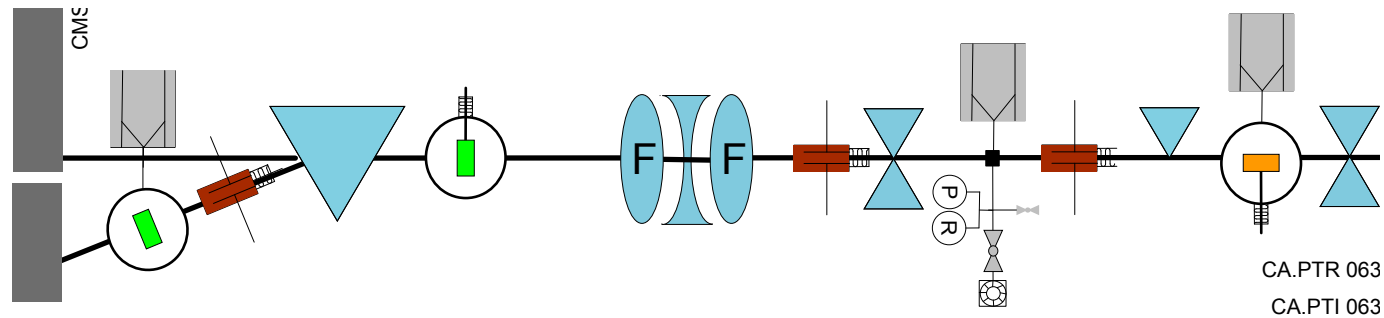

- Use inductive BPMs
- Use screen
- Two Correctors
- Model to propagate through quadrupoles

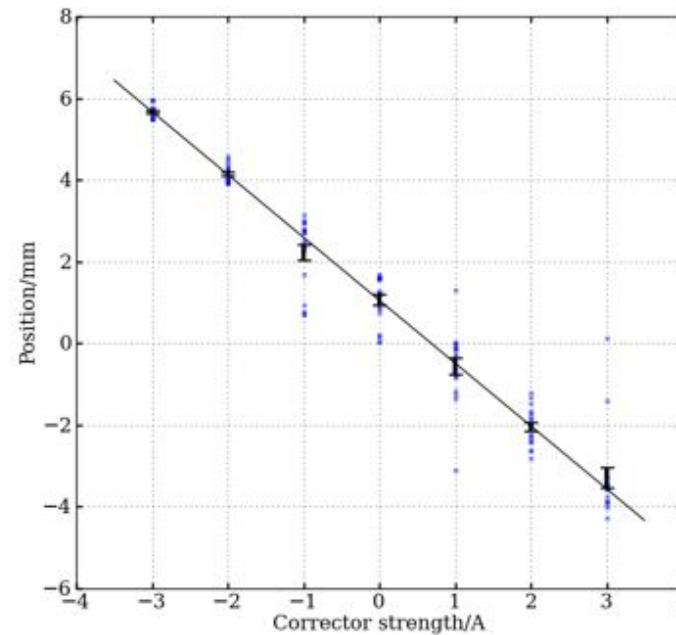

Vertical Calibration Results

- Discrepancies seen between different calibration methods
- For sensitivity estimates, reference cavity sensitivity assumed to be 30V/nC

Method	Phase/ degrees	Standard deviation/ degrees	Scale factor /mm	Standard deviation/mm	Sensitivity /[V/nC/mm]
Single corrector	69.1	0.3	1.14	0.02	5.3
Double corrector	68.6	0.8	0.99	0.02	6.1
Single corrector (screen)	23.7	1.3	1.32	0.03	4.5
Double corrector (screen)	23.5	0.6	1.13	0.19	5.3
Strong focusing (single)	68.2	0.9	0.97	0.03	6.2
Strong focusing (double)	67.4	0.3	1.34	0.05	4.5

Diode Rectifier

- Alternative for sensitivity measurements
- Amplifier and attenuation had to be investigated.
- Prototype system added to reference cavity.
- The signal levels observed are consistent with calculation.

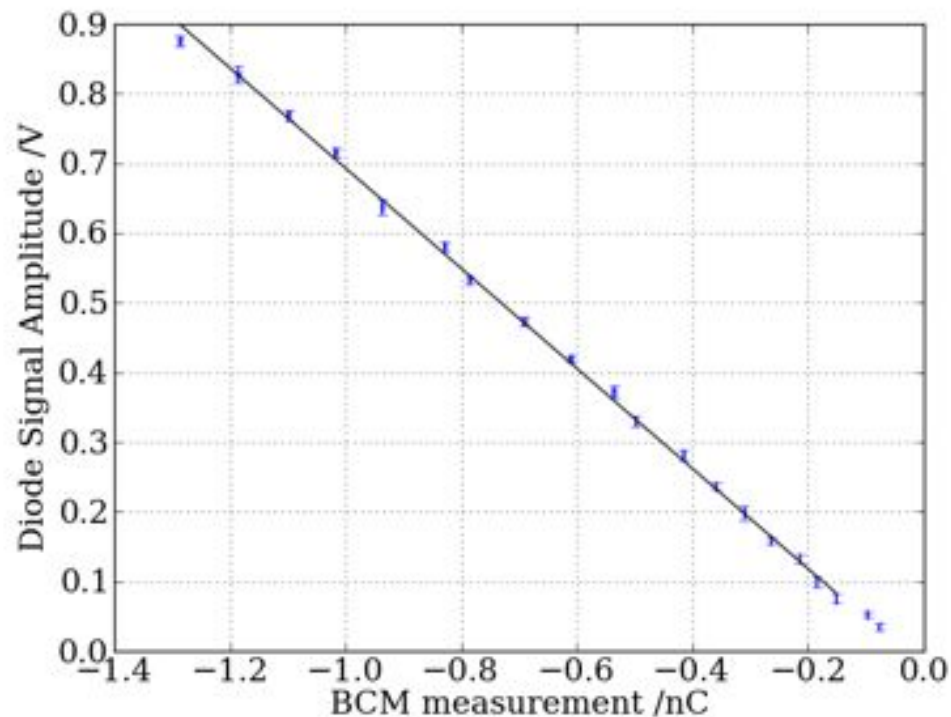

- Charge scan (30ns pulse)
- Gradient-0.719 +/- 0.004
- Sensitivity at cavity estimated using results measured in lab as 25V/nC.
- Good when compared to the downconverted sensitivity of 29.85+/-0.17 V/nC .

Diode Rectifier

- Pulse scans used to observe time response.
- Rise times flatten off at around 30ns, to $12.9\text{ns} \pm 0.3$. This plateau changes somewhat from scan to scan but is still well below the expected and required figure.
- Decay is exponential so fall times don't flatten off

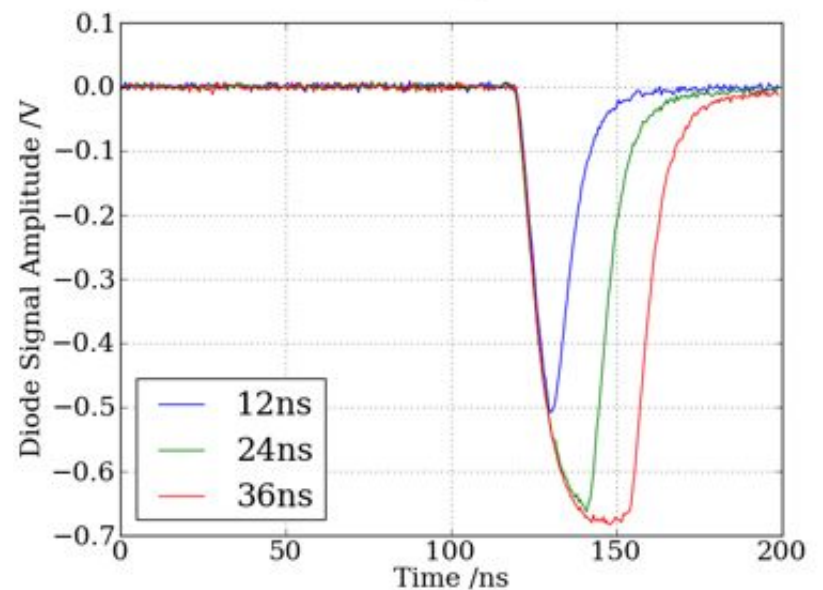
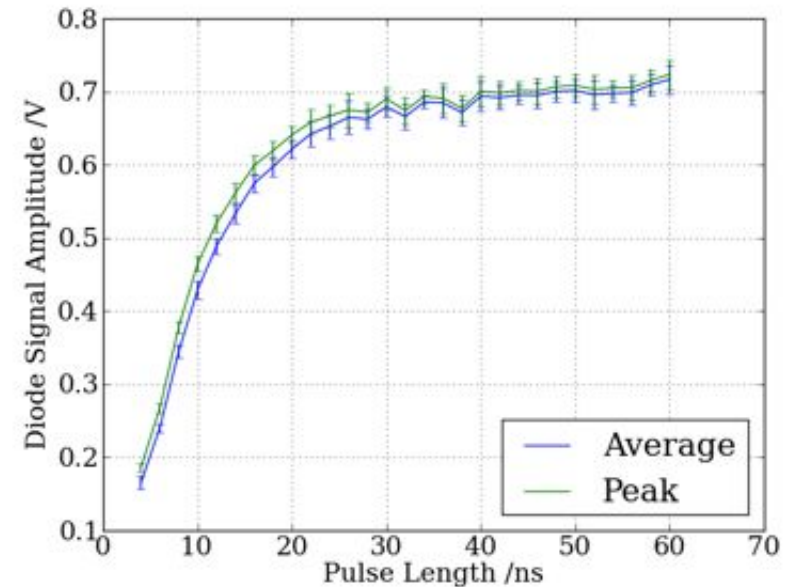
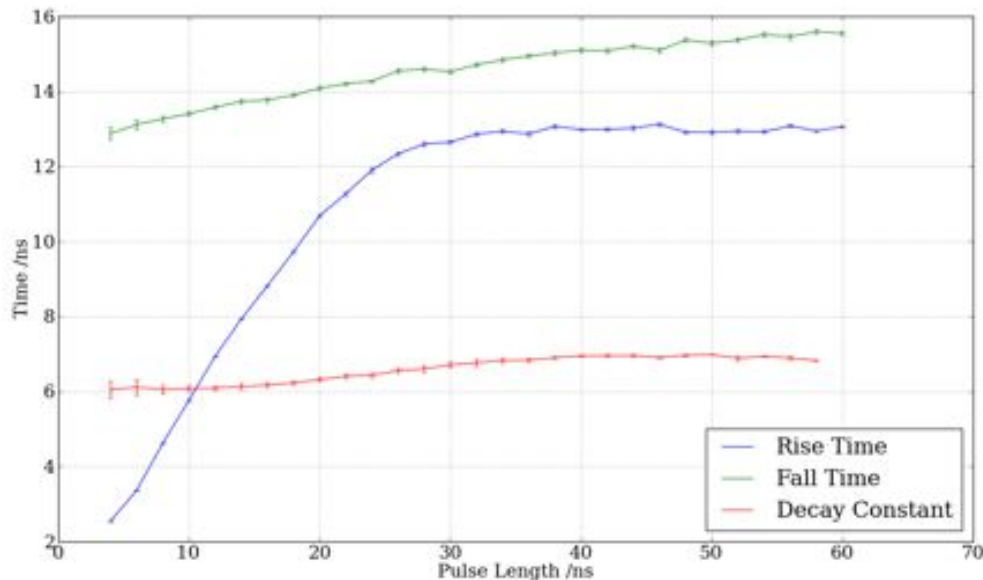

Summary and Outlook

- Calibration:
 - Recently managed to get beam centred in x-y plane
 - Small current ($\sim 2\text{A}$) applied to spectrometer magnet to centre beam
 - Must repeat analysis on calibrations in X
 - Signals already look stable in phase ($< 1^\circ$)
 - Scales are systematically offset for different methods/diagnostics
 - Need to decide which method to trust
 - Use reentrant cavity BPMs upstream to subtract jitter – connectors have just arrived
 - Still waiting on software for movers (hardware ready)
 - Sensitivity is as expected from simulation
- Diode rectifier:
 - Measured sensitivity consistent with simulation and down-converted signal
 - Rise time short enough for targeted 50 ns time resolution
- To be analysed:
 - Data with long bunch trains ($\sim 100\text{ ns}$)
 - Measurement of temporal resolution

Charge Scan

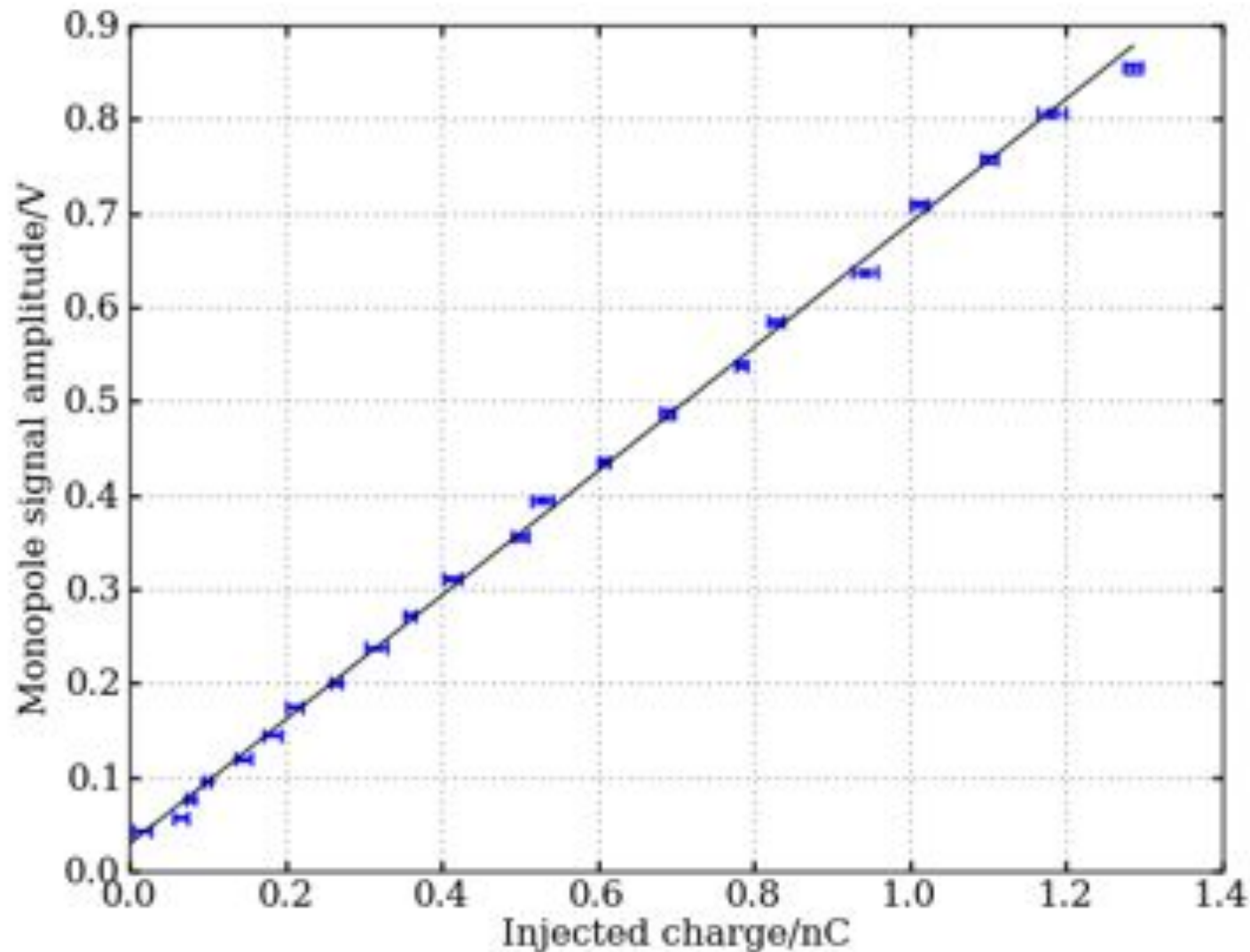

- Injected charge measured using beam charge monitor

- Gradient:
0.661±0.004 V/nC

- Cavity sensitivity:
29.85±0.17 V/nC

- Compares to RF simulation (ACE3P/CST):
52 V/nC

Pulse Length Scan

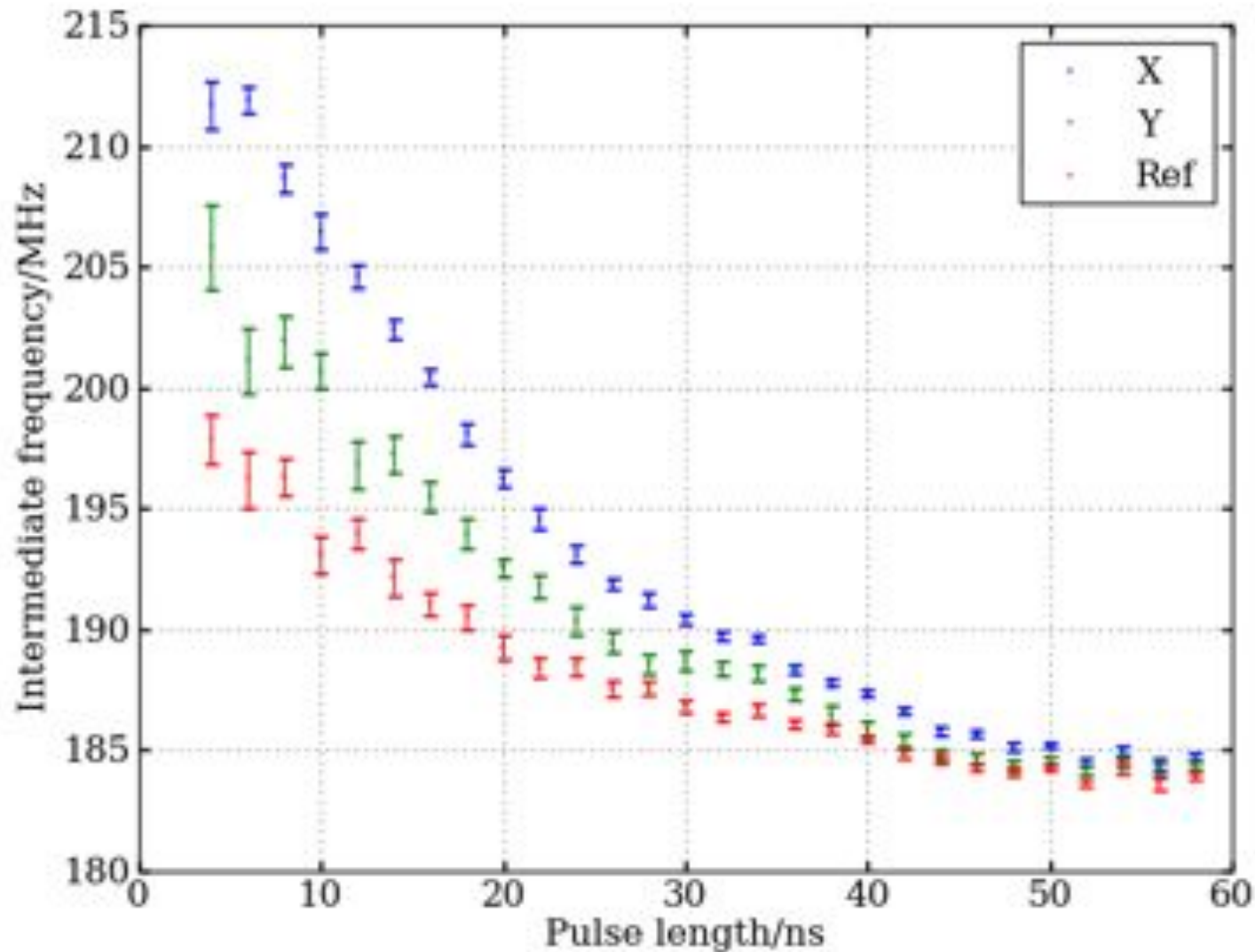

- As pulse length is increased, the dominant signal frequency is the nearest multiple of the bunch repetition frequency.